

RadioShack®



20-501

**PRO-83 200 Channel
compact scanner
w/signal stalker search and
lighted keypad**



Read this user's guide completely
before using your scanner

 **RadioShack**

Contents

The Basics

The FCC wants you to know	4
powering your scanner	5
using rechargeable batteries	7
using AC power	10
using vehicle battery power	11
setting up your scanner	13
connecting the antenna	13
connecting an optional antenna	13
connecting an earphone/headphone	14
listening safely	14
traffic safety	15
connecting an extension speaker	15
attaching the belt clip	16
about your scanner	17
a look at the keypad	18
a look at the display	22
understanding banks	24
service banks	24
channel storage banks	24

Beyond the Basics

operating your scanner	25
turning on the scanner and setting squelch	25
storing known frequencies into channels	25
searching for and temporarily storing active frequencies	28

©2004. RadioShack Corporation. All rights reserved.

RadioShack and RadioShack.com are trademarks used by
RadioShack Corporation.

® RadioShack

- service search 28
- storing frequencies into channels during
 - service search. 29
 - scanning the stored channels. 30
 - manually selecting a channel 30
 - signal stalker 31
 - setting the signal stalker options 32
 - using signal stalker 35
- Skywarn. 36
- about skywarn. 36
- WX alert. 38
- turning on the weather alert feature. 38
- chain search. 38
- chain search mode 39
- chain search hold mode 40
- storing frequencies found during chain
 - search into channel memory 41
- program band select mode 41
- direct entry search 42
- direct entry search hold mode 43
- storing frequencies found during direct
 - entry search into channel memory 44
 - search skip memory 45
 - delay 47
 - turning channel-storage banks on and off 48
 - locking out channels. 48
 - locking out frequencies 49
 - priority 50
 - using keylock. 51
 - wired programming 52
 - using the display/key backlight. 53

® RadioShack	
resetting the scanner	54
frequently asked questions	55
specifications	58
glossary	59
index	60
warranty	63
accessories	64

The FCC Wants You to Know

This equipment has been tested and found to comply with the limits for a Class B digital device, pursuant to Part 15 of the *FCC Rules*. These limits are designed to provide reasonable protection against harmful interference in a residential installation. This equipment generates, uses, and can radiate radio frequency energy and, if not installed and used in accordance with the instructions, may cause harmful interference to radio communications.

However, there is no guarantee that interference will not occur in a particular installation. If this equipment does cause harmful interference to radio or television reception, which can be determined by turning the equipment off and on, the user is encouraged to try to correct the interference by one or more of the following measures:

- Reorient or relocate the receiving antenna.
- Increase the separation between the equipment and receiver.
- Consult your local RadioShack store or an experienced radio/TV technician for help.
- If you cannot eliminate the interference, the FCC requires that you stop using your scanner.

Changes or modifications not expressly approved by RadioShack may cause interference and void the user's authority to operate the equipment.

You must use shielded interface cables with this equipment.

This device complies with Part 15 of the *FCC Rules*. Operation is subject to the following two conditions: (1) this device may not cause harmful interference, and (2) this device must accept any interference received, including interference that may cause undesired operation.

® RadioShack

powering your scanner

You can power your scanner from any of three sources:

- internal batteries (not supplied)
- standard AC power (using an optional AC adapter)
- vehicle battery power (using an optional DC adapter)

Before installing batteries, set the switch in the battery compartment to match the type of batteries you will use. Select ALKALINE for non-rechargeable battery types and RECHARGEABLE for rechargeable battery types, including Ni-Cd and Ni-MH. See also "Using Rechargeable Batteries" on Page 7 when you use rechargeable batteries.

- 1 Remove battery cover and set battery switch.

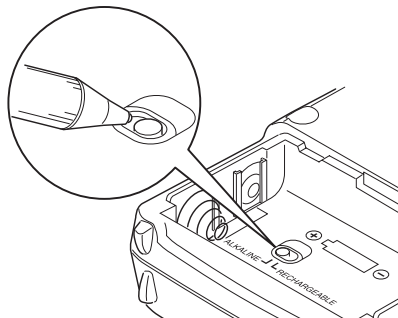

® RadioShack

2 Install 2 AA batteries, matching the polarity symbols (+ -).

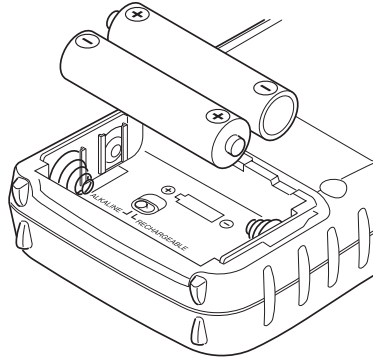

3 Replace the cover.

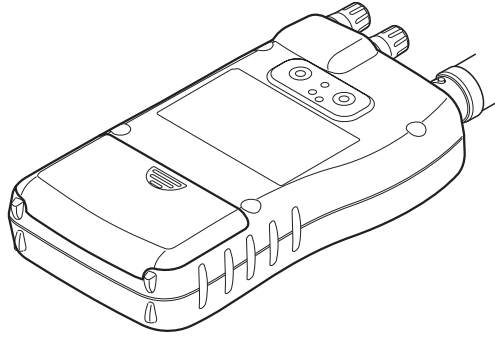

 **RadioShack**

Warning: Set **ALKALINE/RECHARGEABLE** to **RECHARGEABLE** for use only with nickel cadmium (Ni-Cd) or nickel metal hydride (Ni-MH) rechargeable batteries. Never attempt to recharge non-rechargeable batteries. Non-rechargeable batteries can get hot or explode if you try to recharge them.

Cautions:

- Use only fresh batteries of the required size and recommended type.
- Always remove old or weak batteries. Batteries can leak chemicals that destroy electronic circuits.
- Do not mix old and new batteries, different types of batteries (standard, alkaline, or rechargeable), or rechargeable batteries of different capacities.

When  flashes and the scanner beeps every 15 seconds, replace both batteries.

Warning: Always dispose of old batteries promptly and properly. Do not bury or burn them.

Using Rechargeable Batteries

You can also use two rechargeable batteries to power your scanner. Before you use Ni-Cd or Ni-MH batteries, you must charge them.

® RadioShack

The scanner has a built-in circuit that lets you recharge Ni-Cd or Ni-MH batteries while they are in the scanner. To charge the batteries, set **ALKALINE/RECHARGEABLE** inside the battery compartment to **RECHARGEABLE**, install the batteries in the scanner, and connect an external AC or DC adapter to the scanner's DC 6V jack (see "Using AC Power" on Page 10 or "Using Vehicle Battery Power" on Page 11). *CHArg* appears while the scanner is charging the batteries.

Warning: Do not connect either adapter to the scanner if non-rechargeable batteries (such as alkaline batteries) are installed in the scanner and **ALKALINE/RECHARGEABLE** is set to **RECHARGEABLE**, or if you are unsure of the switch's position. Non-rechargeable batteries will get hot and can even explode if you try to recharge them.

Before you use Ni-Cd or Ni-MH batteries for the first time, charge them for 14 hours to bring them to a full charge.

Discharged batteries take about 14 hours to fully recharge.

Notes:

- Ni-Cd batteries last longer and deliver more power if you occasionally let them fully discharge. To do this, simply use the scanner

 **RadioShack**

until it beeps every 15 seconds and  flashes.

- To prevent damage to Ni-Cd and Ni-MH batteries, never charge them in an area where the temperature is above 113°F (40°C) or below 40°F (4°C).
- If you connect an external power source to the scanner with **ALKALINE/RECHARGEABLE** set to **ALKALINE**, *CHArg* appears but the scanner does NOT charge the batteries. This is because the scanner's microprocessor unit does not recognize the switch position when you incorrectly connect an external power source. Make sure that you use the correct batteries and set **ALKALINE/RECHARGEABLE** to the correct position when you connect an external power source.
- If *CHArg* does not appear, the rechargeable batteries might be completely discharged. Connect the scanner to an AC or DC adapter and wait about 1 minute. Then, unplug the adapter from the scanner for a few seconds then plug it back in.

Important: The EPA certified RBRC Battery Recycling Seal on the rechargeable battery indicates RadioShack is voluntarily participating in an industry program to collect



® RadioShack

and recycle these batteries at the end of their useful life, when taken out of service in the United States or Canada. The RBRC program provides a convenient alternative to placing used rechargeable batteries into the trash or the municipal waste stream, which may be illegal in your area. Please call 1-800-THE-SHACK (1-800-843-7422) for information on rechargeable battery recycling and disposal bans/restrictions in your area. RadioShack's involvement in this program is part of the company's commitment to preserving our environment and conserving our natural resources.

Using AC Power

You can power the scanner using a 6V, 300 mA AC adapter and a size B Adaptaplug™ adapter (neither supplied). Both are available at your local RadioShack store.

Cautions:

- You must use a Class 2 power source that supplies 6V DC and delivers at least 300 mA. Its center tip must be set to positive and its plug must fit the scanner's DC 6V jack. Using an adapter that does not meet these specifications could damage the scanner or the adapter.
- Always connect the AC adapter to the scanner before you connect it to AC power. When you finish, disconnect the adapter from AC power before you disconnect it from the scanner.

® RadioShack

Follow these steps to use the scanner on AC power.

- ❶ Make sure the power is turned off.
- ❷ Insert the Adaptaplug into the AC adapter's cord so it reads TIP +. Then, insert the Adaptaplug into the scanner's DC 6V jack.
- ❸ Plug the AC adapter into a standard AC outlet.

Using Vehicle Battery Power



You can power the scanner from a vehicle's 12V power source (such as a cigarette-lighter socket) using a 6V, 300 mA DC adapter and a size B Adaptaplug (neither supplied). Both are available at your local RadioShack store.

Cautions:

- You must use a power source that supplies 6V DC and delivers at least 300 mA. Its center tip must be set to positive and its plug must fit the scanner's DC 6V jack. Using an adapter that does not meet these specifications could damage the scanner or the adapter.
- Always connect the DC adapter to the scanner before you connect it to the power source. When you finish, disconnect the adapter from the power source before you disconnect it from the scanner.

  **® RadioShack**  

- 1** Make sure the power is turned off.
- 2** If the adapter has a voltage switch, set the switch to 6V.
- 3** Insert the Adaptaplug into the DC adapter's cord so it reads TIP +. Then, insert the Adaptaplug into the scanner's DC 6V jack.
- 4** Plug the other end of the adapter into your vehicle's cigarette-lighter socket.

 If rechargeable batteries are installed and **ALKALINE/RECHARGEABLE** is set to **RECHARGEABLE**, the adapter powers the scanner and recharges the installed batteries at the same time. 

Note: If the scanner does not operate properly when you use a DC adapter, unplug the adapter from the cigarette-lighter socket and clean the socket to remove ashes and debris.

 RadioShack

setting up your scanner

Connecting the Antenna

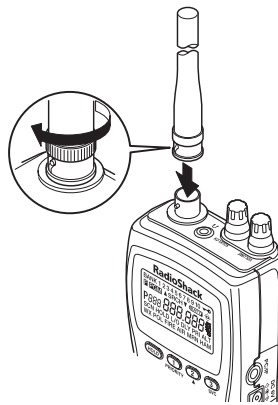

To attach the supplied flexible antenna to the connector on the top of your scanner, align the slots around the antenna's connector with the tabs on the scanner's BNC connector. Then slide the antenna's connector down over the scanner's connector and rotate the antenna connector's outer ring clockwise until it locks into place.

Connecting an Optional Antenna

The scanner's BNC connector makes it easy to connect a variety of optional antennas, including an external mobile antenna or outdoor base station antenna. Your local RadioShack store sells a wide selection of antennas.

® RadioShack

Note: Always use 50-ohm, RG-58, or RG-8, coaxial cable to connect an outdoor antenna. If the antenna is over 50 feet from the scanner, use RG-8 low-loss dielectric coaxial cable. If your antenna's cable does not have a BNC connector, your local RadioShack store carries a variety of BNC adapters.

Connecting an Earphone/Headphone

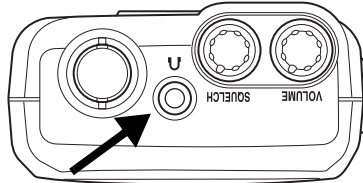

For private listening, you can plug a 1/8-inch (3.5 mm) mini-plug earphone or mono headphones (not supplied) into the headphone jack on top of your scanner. This automatically disconnects the internal speaker.

Listening Safely

To protect your hearing, follow these guidelines when you use an earphone or headphones.

- Do not listen at extremely high volume levels. Extended high-volume listening can lead to permanent hearing loss.
- Set the volume to the lowest setting before you begin listening. After you begin listening, adjust the volume to a comfortable level.

® RadioShack

- Once you set the volume, do not increase it. Over time, your ears adapt to the volume level, so a volume level that does not cause discomfort might still damage your hearing.

Traffic Safety

Do not use an earphone or headphones with your scanner when operating a motor vehicle in or near traffic. Doing so can create a traffic hazard and could be illegal in some areas.

If you use an earphone or headphones with your scanner, be very careful. Do not listen to a continuous broadcast. Even though some earphones/headphones let you hear some outside sounds when listening at normal volume levels, they still can present a traffic hazard.

Connecting an Extension Speaker

In a noisy area, an optional extension speaker, positioned in the right place, might provide more comfortable listening. Plug the speaker cable's 1/8-inch (3.5-mm) mini-plug into your scanner's headphone jack. Your local RadioShack store carries a selection of suitable speakers.

Warning: If you connect an external speaker to the scanner's headphone jack, never connect the audio output line to a power supply and ground. This might damage the scanner.



 RadioShack

Attaching the Belt Clip

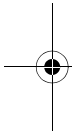
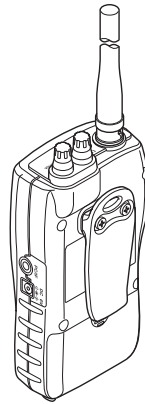
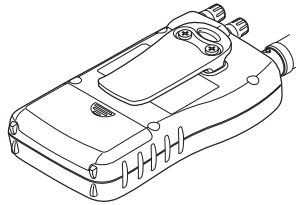

To make your scanner easier to carry when you are on the go, use the supplied belt clip. Use a Phillips screwdriver and the supplied screws to attach the clip to the scanner.

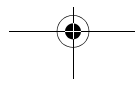
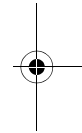



 **RadioShack**

About Your Scanner

We use a few simple terms in this manual to explain the features of the scanner. Familiarize yourself with these terms and the scanner's features, and you can put the scanner to work for you right away. Simply determine the type of communications you want to receive, then set the scanner to scan those communications.

A frequency, expressed in kHz or MHz, is the tuning location of a station. To find active frequencies, you use the search function or refer to a frequency reference.

Besides searching within a selected frequency range, you can also search your scanner's service banks. Service banks are preset groups of frequencies categorized by the type of services that use those frequencies. For example, many amateur radio frequencies are located in the HAM service bank.

When you search and find a desired frequency, you can store it into a programmable memory location called a channel. Channels are grouped into channel-storage banks. The scanner has 10 channel-storage banks and each bank has 20 channels. You can scan the channel-storage banks to see if there is activity on the frequencies stored there.

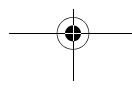
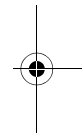
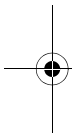

 RadioShack

A Look At the Keypad



Your scanner's keys have various functions labeled on the key tops and below the keys.

To select the function labeled on a key, simply press the key. To select the function labeled below a key, first press **FUNC** then release it. **F** appears on the display. Then quickly press the next key in the function key sequence while **F** appears.

F appears or disappears as you press **FUNC**.

If your scanner's keys seem confusing at first, the following information should help you understand each key's function.

HOLD /  /  :

HOLD Holds the scan or the frequency search. Press and hold **HOLD** to increment channels continuously.

FUNC +  Switches between the three signal stalker modes

 **RadioShack**

SCAN/SRCH:

SCAN Scans the stored channels.

FUNC+ SRCH Starts chain search or resumes searching.

 **/KEYLOCK:**

 Turns the display and key backlight on or off.

FUNC+ KEYLOCK Locks and unlocks the keypad.

FUNC Lets you use various functions by pressing this key in combination with other keys.

 Press and hold for more than 2 seconds to turn the scanner on or off.

1/PRIORITY:

1 Enters a 1.

FUNC + PRIORITY Sets and turns the priority function on or off.

2/▲ :

2 Enters a 2.

FUNC + ▲ Selects the scan or search direction.

 **RadioShack**

3/SVC:

3 Enters a 3.

FUNC + SVC Lets you search the five service search banks.

4/ALT:

4 Enters a 4.

FUNC + ALT Turns the WX alert function on or off.

5/DLY:

5 Enters a 5.

FUNC + DLY Turns the delay function on or off.

6/B.SLCT:

6 Enters a 6.

FUNC + B.SLCT Goes to program band select mode.

7 Enters a 7.

8/▼ :

8 Enters an 8.

FUNC + ▼ Selects the scan or search direction.

 **RadioShack**
9 Enters a 9.

./CLR/  :

./CLR Enters a decimal point or clears an incorrect entry.

FUNC +  Jumps directly to the last channel in memory (Ch#200) from any mode.

0/L/O:

0 Enters a 0.

FUNC + L/O Lets you lock out a selected channel or skip a specified frequency.

E/PGM:

E Enters frequencies into channels.

FUNC+ PGM Programs frequencies into channels.

 RadioShack

A Look at the Display

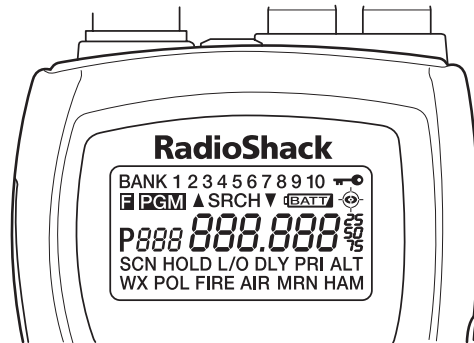

The display has indicators that show the scanner's current operating status. The display information helps you understand how your scanner operates.

BANK - appears with numbers (1-10).

P - appears when you select a priority channel.

SCN - appears when you scan channels.

SRCH - appears during search mode.

PRI - appears when the priority feature is turned on.

HOLD - appears during scan hold mode and search hold mode.

DLY - appears when you select a delay.



 **RadioShack**

L/O - appears when you manually select a channel you locked out or a skip frequency.

 - appears when you lock the keypad.

 - alerts you when the battery power gets low.

 - appears while you store a frequency into a channel.

 or  - appears during search mode.

 - appears only when the function mode is on.

WX, POL FIRE, AIR, MRN, or HAM - appears along with an indicator that shows the current service bank during a service search.

ALT - appears during a WX alert or while the signal stalker function is on.

 - appears when the scanner is set to a signal stalker mode.



 RadioShack

Understanding Banks



Service Banks

The scanner is preprogrammed with all the frequencies allocated to the weather, ham, marine, aircraft, and police (fire/emergency) services.

Channel Storage Banks

To make it easier to identify and select the channels you want to listen to, the 200 channels are divided into 10 channel-storage banks. Each bank has 20 channels. Use each channel-storage bank to group frequencies, such as those for the police department, fire department, ambulance services, or aircraft.

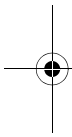

For example, the police department might use four frequencies in your town while the fire department uses an additional four. You could program the four police frequencies starting with Channel 1 (the first channel in bank 1), and program the fire department frequencies starting with Channel 21 (the first channel in bank 2).

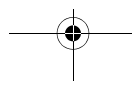
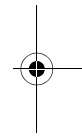

 RadioShack

operating your scanner

Turning On The Scanner and Setting Squelch

Your scanner is preprogrammed at the factory with 150 of the most frequently used frequencies in Channels 1 to 150. You can scan these frequencies as soon as you turn on the scanner.

Note: Make sure the scanner's antenna is connected before you turn it on.

- 1 Turn **SQUELCH** fully counterclockwise.
- 2 Press and hold  for about 2 seconds to turn the scanner on, then turn **VOLUME** clockwise until you hear a hissing sound.
- 3 Turn **SQUELCH** clockwise until the hissing stops.
- 4 Press **SCAN**. See "Scanning the Stored Channels" on Page 30.

Storing Known Frequencies Into Channels

You can locate and store specific frequencies into channels for later use. To assist you in locating a desired frequency from the scanner's wide range, consider using a frequency guide.

  **® RadioShack.**

Excellent references for active frequencies are the *RadioShack Police Call Guide including Fire and Emergency Services*, and *Official Aeronautical Frequency Directory*. We update these directories every year, so be sure to get a current copy.

Follow these steps to store frequencies into channels.

- 1** Press **HOLD**. Then enter the channel number where you want to store a frequency, then press **FUNC + PGM**. The channel number appears.
- 2** Use the number keys and **./CLR** to enter the frequency (including the decimal point) you want to store.
- 3** Press **E** to store the frequency into the channel.

Notes:

- If you entered an invalid frequency in Step **2**, *Error* appears and the scanner beeps three times. Enter a valid frequency.
- The scanner automatically rounds the entered number to the nearest valid frequency. For example, if you enter 151.473 (MHz), your scanner accepts it as 151.475.

 **RadioShack**

• When you enter a frequency into a channel, the scanner automatically turns on the delay function and *DLY* appears. When delay is turned on, the scanner automatically pauses scanning 2 seconds after the end of a transmission before scanning proceeds to the next channel. To turn the function off or on, press **FUNC + DLY**.

• If you enter a frequency that has already been entered elsewhere, the scanner sounds an error tone and displays the channel that was duplicated. If you entered the frequency by mistake, press **./CLR** then enter the correct frequency. To enter the frequency anyway, press **E** to accept.

4 To program the next channel in sequence, press **FUNC + PGM** or **E** and repeat Steps **2** and **3**.

5 To program the scanner with your local Skywarn frequency, repeat Steps **1-3** to program Channel 200 with that frequency. For more information, see "Skywarn" on Page 36.

 **RadioShack.**

Searching For and Temporarily Storing Active Frequencies

If you do not have a reference to frequencies in your area, use a search (except weather service search) to find a transmission.

Note: When the scanner starts searching, it automatically turns on the delay function. To turn delay on or off, press **FUNC + DLY**.

Service Search

You can search for weather, ham, marine, aircraft, or police (fire/emergency) transmissions without knowing the specific frequencies used in your area. The scanner is preprogrammed with all the frequencies allocated to these services. To use this feature, press **FUNC + SVC**. *SRCH* appears and the scanner searches starting with the weather service bank. To select a different service bank, repeatedly press **FUNC + SVC**. Service mode appears on the display.

When the scanner stops on a transmission, quickly press **HOLD** to stop searching and listen to the transmission. *HOLD* appears. In this mode, you can press **FUNC + ▲** or **FUNC + ▼** to step through the frequencies.

® RadioShack

To release the hold and continue searching, press **HOLD**. Or, if you did not press **HOLD**, simply press **FUNC** + **▲** or **FUNC** + **▼** to continue searching.

Note: Because there are many different frequencies allocated to fire and police departments, it can take several minutes to search all the service frequencies.

Storing Frequencies into Channels During Service Search

You can store frequencies you found during service search or service search hold mode into channels.

- 1 Press **FUNC** + **PGM** during service search or service search hold mode. The frequency and the lowest blank channel alternately appear.
- 2 Press **E** to store the frequency into the blank channel. If you want to select another channel, press **FUNC** + **▲** or **▼** before you press **E**. To enter the frequency, press **FUNC**.

F disappears. Then press **E**. You can also use the **0-9** keys to select the bank. To continue searching, press **FUNC** + **SVC**.

If you entered a frequency that has already been entered elsewhere, the scanner sounds an error tone and displays the channel that was duplicated. If you entered the frequency by mistake, press **./CLR** then enter the correct frequency. To enter the frequency anyway, press **E** to accept.

 **RadioShack**

Scanning the Stored Channels

To begin scanning channels, press **SCAN**. The scanner scans through all non-locked channels in the activated banks. (See "Locking Out Channels" on Page 48 and "Turning Channel-Storage Banks On and Off" on Page 48). When the scanner finds a transmission, it stops on it. When the transmission ends, the scanner resumes scanning.

Notes:

- If you have not stored frequencies into any channels, the scanner does not scan.
- If the scanner picks up unwanted partial, or very weak transmissions, turn **SQUELCH** clockwise to decrease the scanner's sensitivity to these signals. To listen to a weak or distant station, turn **SQUELCH** counterclockwise.
- To ensure proper scanning, adjust **SQUELCH** until the audio mutes.

Manually Selecting a Channel

You can continuously monitor a single channel without scanning. This is useful if you hear an emergency broadcast on a channel and do not want to miss any details - even though there might be periods of silence - or if you want to monitor a specific channel.

® RadioShack

To manually select a channel, press **HOLD**, enter the channel number then press **HOLD** again.

Or, during scanning, if the radio stops at a channel you want to listen to, press **HOLD** once. (Repeatedly pressing **HOLD** at this time causes the scanner to step through the channels.) Press **SCAN** to resume automatic scanning.

Signal Stalker

Your scanner's Signal Stalker feature lets you set the scanner so it detects then displays the frequency of a nearby strong radio transmission. You can set the scanner so Signal Stalker works "in the background" while you are scanning other frequencies, turn off normal scanning while Signal Stalker is working, or turn off Signal Stalker and use the scanner normally. You can set the scanner so it alerts you when Signal Stalker finds a frequency. You can also set the frequency band where you want the scanner to look for transmissions.

Notes:

- Signal Stalker works well for locating the source of strong local transmissions such as mobile and handheld two-way radios in areas with no other strong transmission sources. However, if you are in an area with many transmission sources (such as pager radio transmitters, multi-use radio towers, traffic control devices, etc.),

 **RadioShack.**

Signal Stalker might not find the transmission you are searching for, or it might find a transmission other than the one you are searching for. You can screen unwanted transmissions by pressing **FUNC** + **L/O** to lock them out. See “Locking Out Frequencies” on Page 49 for more information.

- Signal Stalker cannot detect satellite dishes or any transmitter with a frequency above or below the frequency ranges listed under “Setting the Signal Stalker Options” on Page 32.
- Signal Stalker works better with some types of transmissions than others. It might not correctly display frequency information for transmitters using a highly directive antenna (such as an amateur radio beam antenna), if there are many transmitters operating at the same time in the same area, or if the transmitter is a broadcast television station.

Setting the Signal Stalker Options

1 Press **FUNC** then press and hold  for 2 seconds. One of the following signal stalker options appears.

S-S.band: Lets you select the signal stalker band.

S-S.ALt: Lets you select the signal stalker alert settings.

 **RadioShack**

- 2 Repeatedly press ▲ or ▼ to select the option you want, then press **E**.

If you selected *S-S.bnd*, one of the following band names appears.

bnd Lo: VHF Low Band (25.0000 - 54.0000 MHz)

bnd Air: AIR Band (108.0000 - 136.9875 MHz)

bnd Hi: VHF High Band (137.0000 - 174.0000 MHz)

bnd UHF: UHF Band (406.0000 - 512.0000 MHz)

bnd 800: 800MHz Band (806.0000 - 956.0000 MHz)

If you selected *S-S.Alt*, skip to Step 4.

- 3 Repeatedly press ▲ or ▼ until the band you want to search appears, then press **E** to select it. Otherwise, press **./CLR** if you do not want to select it.

The scanner displays the following options.

Lo On or *Lo OFF*

Air On or *Air OFF*

Hi On or *Hi OFF*

UHF On or *UHF OFF*

800 On or *800 OFF*

   
® RadioShack.

4 Repeatedly press **▲** or **▼** until the option you want appears, then press **E** to select it. Otherwise, press **./CLR** if you do not want to select it. Then skip to Step **7**.

5 Press **E** while *S-S.Alt* appears. One of the following alert options appears.

ALt bEEP: The scanner beeps when a signal stalker signal is detected.

ALt Light: The scanner flashes the display backlight when a signal stalker signal is detected.

ALt bP-Lt: The scanner flashes the display backlight and beeps when a signal stalker signal is detected.

ALt OFF: The scanner does not provide any alert when a signal stalker signal is detected.

6 Repeatedly press **▲** or **▼** until the option you want appears, then press **E** to select it. Otherwise, press **./CLR** if you do not want to select it.

7 When you select the option, press **./CLR** to exit the option mode. Otherwise, to continue normal scanning, repeatedly press **FUNC** until **F** disappears then press **SCAN**.

 **RadioShack**



Using Signal Stalker



To turn on Signal Stalker, turn **SQUELCH** fully clockwise, then press **FUNC** +  once except in WX search, band select, or program mode.

 appears. Every 2 seconds, the scanner searches for frequencies in the range you specified in "Setting the Signal Stalker Options" on Page 32.

Note: To continue scanning normally while Signal Stalker is working, simply press **SCAN**.

When the scanner finds a frequency, it sounds the alert you specified in "Setting the Signal Stalker Options" on Page 32, and *Found* flashes. Press any key to confirm the displayed frequency. Press **SCAN** to resume scanning. Or press **▲** or **▼** while the frequency and **F** appear to select the band where you are searching.

To turn on Signal Stalker and turn off normal scanning, press **FUNC** +  twice.  and - - - - - flash.

To turn off Signal Stalker and turn on normal scanning, press **FUNC** +  three times.  disappears.

 **RadioShack**

Skywarn

The Skywarn function lets you jump directly to the last channel in memory (Channel 200) from any mode by pressing **FUNC** + . The scanner goes into scan hold mode and starts receiving transmissions in the last channel. If no frequency is programmed in the last channel, *No Prg* appears and the scanner sounds an error tone.

About Skywarn

Skywarn is an organized group of trained weather observers. A Skywarn group exists in virtually every US county with a significant population. During inclement weather, reports made by Skywarn observers include information about:

- pea-sized and larger hail
- wind and wind gusts 40 MPH and greater
- heavy rainfall
- lightning (cloud-to-cloud and especially cloud-to-ground)
- wall clouds seen in severe thunderstorms (which spawn tornadoes)
- severe lowering of a wall cloud
- turbulence in a wall cloud
- funnel clouds
- tornadoes



® RadioShack

- high water areas
- downed power lines
- other emergency conditions that affect life or property

Listening to Skywarn broadcasts makes it easy to quickly find out about and prepare for inclement weather conditions in your immediate area, even before your local NOAA weather broadcast and local TV or radio station can announce them.

Enter the local Skywarn frequency for your area into Channel 200 on your scanner, then listen to Skywarn first when severe weather threatens.

Listen to NOAA: for weather alerts and warnings, watch box notices, and weather forecasts

Listen to Skywarn: to hear trained observers in your vicinity call in official reports to a "net control" station who relays those reports to NOAA and other emergency agencies.

If you tune to a Skywarn frequency when the Skywarn net is not active, you may hear nothing or you may hear amateur radio operators talking on a local repeater system.

Most importantly, you get Skywarn reports directly from trained observers - that means you get them several minutes before they can be relayed for

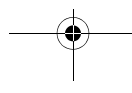
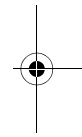
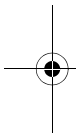



 **RadioShack**

broadcast by NOAA and as much as 5 or 10 minutes sooner than you will hear them on local TV or radio! Those few minutes can be worth a lot when it comes to deciding if your family needs to take cover.



WX Alert

Turning On the Weather Alert Feature

Turn on the WX alert function by pressing **FUNC + ALT** in the WX search or WX search hold mode. *ALT* appears. When the scanner receives a WX alert signal while the WX alert function is on, it goes into WX alert hold mode and generates a WX alert tone, and *ALT* flashes. To stop the WX alert tone, press any key. *ALT* disappears.

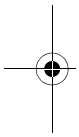

Chain Search

This feature lets you search through preset frequency ranges. You can also change each range to a range you set. There are three modes within this feature: chain search mode, chain search hold mode, and program band select mode.

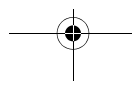
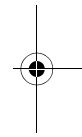

 **RadioShack**

The preset frequency ranges are:

Bank No.	Frequency (MHz)	Step (kHz)
1	25.0000-27.9950	5
2	28.0000-29.6950	5
3	29.7000-49.9950	5
4	50.0000-54.0000	5
5	137.0000-143.9950	5
6	144.0000-147.9950	5
7	406.0000-419.99375	6.25
8	420.0000-449.99375	6.25
9	450.0000-469.99375	6.25
10	806.0000-956.0000	12.5

Chain Search Mode

Press **FUNC + SRCH** to start chain search mode. **SRCH**, the enabled search bank number, and **▲** or **▼** (indicating the search direction) appear. The search bank number being searched flashes.

Press **0-9** to enable or disable the search bank number being searched in this mode. Enabled bank numbers appear. (Disabled bank numbers disappear).

  **® RadioShack.**  

At least one search bank must be enabled. (The scanner sounds an error tone if you try to disable all the search banks). The search bank and the frequency where chain search starts depends on how the scanner was set before you selected chain search mode.

Chain Search Hold Mode

To start chain search hold mode, press **HOLD** in chain search mode. The scanner stops searching and *HOLD* appears. In this mode, pressing **FUNC** + **▼** changes the search direction downward and pressing **FUNC** + **▲** changes the search direction upward. **▼** or **▲** appears according to the current search direction.

Pressing **▼** while **F** appears decreases the frequency by one step and pressing **▲** increases it by one step. Hold down **▼** or **▲** to quickly decrease or increase the frequency. To resume chain search, press **HOLD** if **F** does not appear on the display or press **SRCH** if **F** appears on the display.

 **RadioShack**

Storing Frequencies Found During Chain Search into Channel Memory

You can store frequencies you find in chain search mode or chain search hold mode.

- 1 Press **FUNC** + **PGM** in chain search mode or chain search hold mode. The lowest blank channel and bank appear.
- 2 Press **E** to store the frequency into the blank channel. To select another channel, press **FUNC** + **▲** or **▼** before you press **E**. To enter the frequency, press **FUNC**. **F** disappears. Then press **E**. You can also press **0-9** to select the bank.

If you try to save a frequency that is already stored, the scanner sounds an error tone and displays the channel that was duplicated. If you entered the frequency by mistake, press **./CLR**. To enter the frequency anyway, press **E** to accept.

The scanner sets itself to program mode after you store a frequency.

Program Band Select Mode

You can use this mode to define the search range used during a chain search in each search bank. To set the scanner to program band select mode, press **FUNC** + **B.SLCT**. *SEARCH* appears. Then select a search bank.

 **RadioShack.**

When you select the search bank, the lower limit and upper limit frequency assigned in the search bank alternate on the display.

To select another search bank, press **FUNC + B.SLCT** or **FUNC ▲** to increase the search bank number or **FUNC + ▼** to decrease it. Hold down **FUNC + ▲** or **FUNC + ▼** for about 1 second to quickly move through the search bank numbers.

After choosing the search bank, follow these steps to set the lower limit and upper limit frequency.

- 1 Enter the lower limit frequency by using the **0-9** and **./CLR** keys.
- 2 Press **E** to select the lower limit frequency.
- 3 Enter the upper limit frequency by using the **0-9** and **./CLR** keys.
- 4 Press **E** to select the upper limit frequency.

Direct Entry Search

You can use direct entry search to search up or down from the currently displayed frequency.

- 1 If the scanner is scanning or searching, press **HOLD**.

® RadioShack

- ② Enter the frequency you want to start from by using the number keys. (Press **./CLR** to enter a decimal point).
- ③ Press **FUNC** + **▲** or **▼**. The scanner searches, starting from the frequency you entered in Step ②.

If you enter a frequency that is out of range, the scanner sounds an error tone and *Error* appears.

Press **FUNC** + **▼** to change the search direction downward or **FUNC** + **▲** to change the search direction upward. Frequencies appear during the search.

Notes:

- You can set the delay function on or off during the search or while the search stops.
- You can skip a frequency when the search stops. After the search skip frequency is set, the scanner starts direct search again.

Direct Entry Search Hold Mode

To stop searching during direct entry search, press **HOLD**. *HOLD* appears. In this mode, pressing **FUNC** + **▼** changes the search direction downward and pressing **FUNC** + **▲** changes the search direction upward. **▼** or **▲** appears depending on the search direction.

 **RadioShack.**

Press **FUNC** + **▼** to decrease the frequency by one step or **FUNC** + **▲** to increase it by one step. Hold down **▼** or **▲** for about 1 second to quickly decrease or increase the frequency.

To resume direct search, press **FUNC** + **SEARCH** or **HOLD**. (**▼** or **▲** appears on the display, showing the search direction).

Storing Frequencies Found During Direct Entry Search into Channel Memory

Follow these steps to store frequencies received during direct entry search mode or direct entry search hold mode.

- 1 Press **FUNC** + **PGM** in direct entry search mode or direct entry search hold mode. The frequency and lowest blank channel alternate on the display.
- 2 Press **E** to store the frequency into the blank channel. To select another channel, press **FUNC** + **▲** or **▼**. Then press **FUNC**. **F** disappears. Then press **E**. You can also use the **0-9** keys to select the bank.

If you enter a frequency that has already been entered elsewhere, the scanner sounds an error tone and displays the channel that was duplicated. If you entered the frequency by mistake, press



® RadioShack

./CLR. To enter the frequency anyway, press **E** to accept.

The scanner moves to program mode after you stored the frequency.

Search Skip Memory

You can skip up to 50 specified frequencies during a search. This lets you avoid unwanted frequencies or those already stored in a channel.

Notes:

- You cannot skip frequencies during WX service search.
- Search skip frequencies are shared by service search, direct entry search, chain search, and signal stalker modes. If skip frequencies are set in certain mode, the frequencies are also skipped in other search modes and signal stalker mode.

To skip a frequency, press **FUNC + L/O** when the scanner stops on the frequency during a search or a search hold. The scanner stores the frequency in memory and automatically resumes the search if it is not in hold.

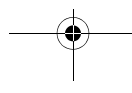
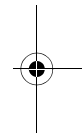
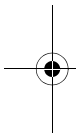

 **RadioShack.**

Follow these steps to clear a single frequency from skip memory so the scanner stops on it during a search.

- ❶ Press **HOLD** to stop the search.
- ❷ Press **FUNC** + ▲ or **FUNC** + ▼ to select the frequency. *L/O* appears.
- ❸ Press **FUNC** + **L/O**. *L/O* disappears.

To clear all the skip frequencies at once while searching or search hold, press **FUNC** then press and hold **L/O** until the scanner beeps.

Notes:

- If you selected all frequencies to be skipped within the search range, the scanner beeps 3 times and does not search.
- If you select more than 50 frequencies to skip, each new frequency replaces a frequency previously stored, beginning with the first stored frequency.
- Press **FUNC** + ▲ or **FUNC** + ▼ to select a skipped frequency while *HOLD* appears. *L/O* appears when you select a skipped frequency.

 **RadioShack**

Delay

Sometimes a user might pause before replying to a transmission. To avoid missing a reply on a specific channel, you can program a 2-second delay into any channel or frequency. The scanner continues to monitor the channel frequency for an additional 2 seconds after the transmission stops before resuming scanning or searching. The scanner automatically sets a delay when you store frequencies into channels or when you search frequencies. When the delay feature is on, *DLY* appears. If it is off, follow one of these steps to program a delay depending on how the scanner is operating.

- If the scanner is scanning and stops on an active channel where you want to store a delay, quickly press **FUNC + DLY** before it continues scanning again. *DLY* appears.
- If the desired channel is not selected, manually select the channel, then press **FUNC + DLY**. *DLY* appears.
- If the scanner is searching, press **FUNC + DLY** while the scanner is searching. *DLY* appears and the scanner automatically adds a 2-second delay to every frequency it stops on in that band.

To turn off the 2-second delay, press **FUNC + DLY** while the scanner is monitoring a channel, scanning, or searching. *DLY* disappears.

 **RadioShack**

Turning Channel-Storage Banks On and Off

You can turn each channel-storage bank on and off. When you turn off a bank, the scanner does not scan any of the 20 channels in that bank.

While scanning, press the number key that corresponds to the bank you want to turn on or off. Numbers appear at the top of the display, showing the currently selected banks.

The scanner scans all the channels within the displayed banks that are not locked out (see "Locking Out Channels"). The bank number flashes when the scanner scans a channel that belongs to the bank.

Notes:

- You can manually select any channel within a bank, even if that bank is turned off.
- You cannot turn off all banks. One bank must always be active.

Locking Out Channels

You can increase the scanning speed by locking out channels that have a continuous transmission, such as a weather channel. To lock out a channel, manually select the channel, then press **FUNC + L/O**. *L/O* appears.

 **RadioShack**

Notes:

- The scanner does not skip locked-out channels when you use Signal Stalker. You must lock out frequencies instead. See “Locking Out Frequencies.”
- You can still manually select locked-out channels.

To remove the lockout from a channel, manually select the channel, then press **FUNC + L/O**. *L/O* disappears.

To unlock all channels in the banks that are turned on, press **HOLD** to stop scanning, then press **FUNC** and press and hold **L/O** until the scanner beeps twice.

Locking Out Frequencies

While searching and using Signal Stalker, you can reduce the number of “hits” from frequencies you do not want to find by locking out frequencies that have a continuous transmission, such as a radio pager.

Press **FUNC + L/O** to lock out a frequency. *L/O* appears.

 **RadioShack**

Priority

The priority feature lets you scan through the channels and still not miss important or interesting calls on specific channels. You can program one stored channel in each bank as a priority channel (10 for the banks).

If the priority feature is turned on, as the scanner scans the bank, it checks that bank's priority channel for activity every 2 seconds.

The scanner automatically designates each bank's first channel as its priority channel.

Follow these steps to select a different channel in a bank as the priority channel.



- 1 Manually select the channel you want to select as the priority channel.
- 2 Press **FUNC + PGM**, then press **FUNC + PRIORITY**. *P* appears to the left of the selected channel number.
- 3 Repeat Steps 1 and 2 for the channel in each bank you want to program as a priority channel.



To turn on the priority feature, press **FUNC + PRIORITY** during scanning. *PR!* appears. Then the scanner checks the designated priority channel every 2 seconds in each bank.

 **RadioShack**

To turn off the priority feature, press **FUNC + PRIORITY**. *PRI* disappears.

Using Keylock

Use the scanner's keylock to protect it from accidental program changes. When the scanner's keys are locked, the only controls that operate are **SCAN, FUNC, HOLD, , KEYLOCK,** and .

To turn on keylock, press **FUNC + KEYLOCK**.  appears. To turn off keylock, press **FUNC + KEYLOCK**.  disappears.

Note: Using keylock does not prevent the scanner from scanning channels.

 RadioShack.

Wired Programming

You can transfer programming data to your scanner using your PC and an optional interface cable (Cat. No. 20-289, available at your local RadioShack store) and software (available at your local RadioShack or www.radioshack.com).

Note: If the scanner receives no data from the PC for more than 20 seconds, *T-Err* appears and wired programming stops.

- 1 Make sure your scanner is turned off.
- 2 Connect the interface cable to your computer then connect the other end of the cable to **PC/IF** on the side of the scanner.

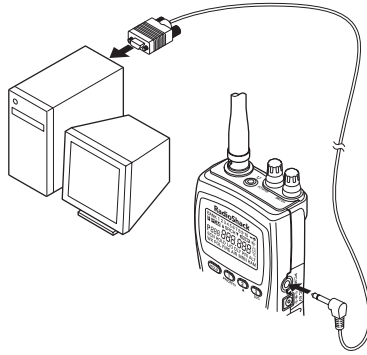

- 3 Install the software to your computer and run the program.



® RadioShack

- ④ To set up the program, click on Tools, select Configuration, and select PRO-83 (if necessary).
- ⑤ Turn on the scanner. The scanner automatically goes into the wired programming mode. *PGM* and *WirEd* appear. Then send the data from the PC.

Data frame numbers being received appear.

- ⑥ When the scanner has successfully received all data, *End* appears. If the scanner received an error while receiving data, *End*, *d-Err*, and its frame number appear. If the scanner received a communication error while receiving data, *C-Err* indicates the packet number where the error occurred. If the scanner received a checksum error while receiving data, *S-Err* indicates the packet number where the error occurred. If the scanner received a length field error while receiving data, *L-Err* indicates the packet number where the error occurred.

Using the Display/Key Backlight

To turn on the display/key light for easy viewing at night, press . The display lights for 15 seconds. To turn off the light sooner, press  again.

 **RadioShack**

Resetting the Scanner

If the scanner's display locks up or stops operating properly, you might need to reset the scanner.

Caution: This procedure clears all the information you have stored in the scanner. Before you reset the scanner, try turning it off and on to see if it begins working properly. Reset the scanner only when you are sure it is not working properly.

- 1 Make sure your scanner is turned off.
- 2 While holding down **2**, **9**, and **HOLD**, turn on the scanner. After about 3 seconds, the scanner initializes and *CLEAR* appears.

Follow these steps to restore the 150 preprogrammed frequencies stored in the scanner.

- 1 Make sure your scanner is turned off.
- 2 While holding down **3** and **E**, turn on the scanner. After several seconds, the scanner restores the frequencies and *-LoAd-* appears.

 **RadioShack**

frequently asked questions

Q: *My scanner isn't working at all. How do I turn it on?*

A: The scanner might not be receiving power. Make sure the batteries are installed correctly and are good (if you installed alkaline batteries) or fully charged (if you installed rechargeable batteries). See "powering your scanner" on Page 5 for more information.

If the batteries are good, make sure the AC adapter's or DC adapter's barrel plug is fully inserted into the scanner's 6V 300 mA jack. See "Using AC Power" on Page 10 for more information.

If the scanner is receiving power, make sure it is turned on. See "Turning On The Scanner and Setting Squelch" on Page 25 for more information.

Q: *My scanner is on but won't scan. How do I get it to scan?*

A: Make sure the squelch is adjusted correctly. See "Turning On The Scanner and Setting Squelch" on Page 25 for more information.

If the squelch is set correctly, you might not have stored frequencies into any channels or only one channel. You must store at least two frequencies for the scanner to scan. See "Storing Known Frequencies Into Channels" on Page 25 for more information.

 **RadioShack**

Q: *The scanner's display is dim and hard to see. The scanner also beeps once every 15 to 30 seconds. What's wrong?*

A: The scanner might not be receiving enough power or the batteries might not be correctly installed. Make sure the batteries are installed correctly and are good (if you installed alkaline batteries) or fully charged (if you installed rechargeable batteries). See "powering your scanner" on Page 5 for more information.

Q: *Nothing happens when I press the scanner's keys. How do I get the keys to work?*

A: The scanner's keylock might be turned on. To turn off keylock, press **FUNC** and **KEYLOCK** until  disappears. See "Using Keylock" on Page 51 for more information.

Q:  *flashes on the display. What is it?*

A: The batteries might be weak. Make sure the batteries are good (if you installed alkaline batteries) or fully charged (if you installed rechargeable batteries). See "powering your scanner" on Page 5 for more information.

Q: *My scanner is not receiving anything or reception is weak. What's wrong?*

A: The batteries might be weak. Make sure the batteries are good (if you installed alkaline batteries)

® RadioShack

or fully charged (if you installed rechargeable batteries). Also make sure the AC adapter's or DC adapter's barrel plug is fully inserted into the scanner's 6V 300 mA jack. See "Using AC Power" on Page 10 for more information.

If the batteries are OK, the antenna might not be connected or is connected incorrectly. See "Connecting the Antenna" on Page 13 for more information.

Q: *My scanner is not receiving weather channels. How do I set it so I can receive weather channels?*

A: The scanner might be set to weather alert mode. If this happens, it cannot receive weather channels until it receives a weather alert. To hear a weather channel at any time, make sure weather alert is turned off. See "WX Alert" on Page 38 for more information.

Q: *Error appears on the display. What does it mean?*

A: If you were trying to enter a frequency, you might have made a programming error. Re-enter the frequency correctly, including the decimal point. See "Storing Known Frequencies Into Channels" on Page 25 for more information.

 **RadioShack**

Specifications

Frequency Coverage:

25.0000-27.9950 MHz (in 5 kHz steps)
28.0000-29.9950 MHz (in 5 kHz steps)
30.0000-49.9950 MHz (in 5 kHz steps)
50.0000-54.0000 MHz (in 5 kHz steps)
108.0000-136.9875 MHz (in 12.5 kHz steps)
137.0000-143.9950 MHz (in 5 kHz steps)
144.0000-147.9950 MHz (in 5 kHz steps)
148.0000-174.0000 MHz (in 5 kHz steps)
406.0000-419.99375 MHz (in 6.25 kHz steps)
420.0000-449.99375 MHz (in 6.25 kHz steps)
450.0000-469.99375 MHz (in 6.25 kHz steps)
470.0000-512.0000 MHz (in 6.25 kHz steps)
806.0000-823.9875 MHz (in 12.5 kHz steps)
849.0125-868.9875 MHz (in 12.5 kHz steps)
894.0125-956.0000 MHz (in 12.5 kHz steps)

Operating Temperature:

Normal -4° to 140°F (-20° to 60°C)
Signal Stalker 14° to 122°F (-10° to 50°C)

IF Frequencies

1st (25-174 MHz)	380.6050-380.7000 MHz
1st (406-512 MHz)	380.6125-380.7000 MHz
1st (806-956 MHz)	380.7000-380.7875 MHz
2nd	21.3 MHz
3rd	450 kHz

Specifications are typical; individual units might vary.
Specifications are subject to change and improvement
without notice.

 **RadioShack**

glossary

ALKALINE/RECHARGEABLE Switch - Lets you select the type of batteries you want to use in the scanner (alkaline or rechargeable) 5

Channel - a programmable memory location. Channels are grouped into channel-storage banks. Your scanner has 10 channel-storage banks and each bank has 20 channels. 17

Channel-Storage Banks - Groups of channels, used for frequency storage. 24

Service Banks - preset groups of frequencies categorized by the type of services that use those frequencies. 17, 24

Signal Stalker - lets you set the scanner so it detects then displays the frequency of a nearby strong radio transmission. 31

Skywarn - lets you jump directly to the last channel in memory (Channel 200) from any transmission. You can program this channel with the frequency of your local Skywarn broadcaster. 36

 **RadioShack**
index

Accessories 64

ALKALINE/RECHARGEABLE Switch 5

Antenna
 Connecting 13
 Using an Optional Antenna 13

Attaching a belt clip 16

Backlight 53

Batteries
 Charging 5
 Installing 5

Belt Clip
 Attaching 16

Chain Search 38
 Mode 39
 Hold Mode 40
 Storing Frequencies 41

Channel-Storage Banks 24, 48

Connecting an antenna 13

Connecting an earphone 14

Connecting an extension speaker 15

Beyond the Basics **60**

® RadioShack	
Delay	47
Direct Entry Search	42
Earphone	
Connecting	14
Extension Speaker	
Connecting	15
Frequently Asked Questions	55
FUNC Key	19
Keylock	51
Locking Out Channels	48
Locking Out Frequencies	49
Manually Selecting Channels	30
Priority	50
Powering the scanner	
Using Batteries	5
Using AC Power	10
Using Vehicle Battery Power	11
Program Band Select Mode	41
Resetting the Scanner	54
Scanning	30

® RadioShack

Search Skip Memory	45
Service Banks	24
Service Search	28
Squelch	
Setting	25
Storing frequencies	25
During Service Search	29
Direct Entry Search Mode	42
Chain Search Mode	39
Signal Stalker	31
Locking Out Frequencies	49
Setting Options	32
Using	35
Skywarn	36
Specifications	58
Turning on the scanner/setting squelch	25
Weather Alert	38
Wired Programming	52

 **RadioShack**

warranty

This product is warranted by RadioShack against manufacturing defects in material and workmanship under normal use for 90 (ninety) days from the date of purchase from RadioShack company-owned stores and authorized RadioShack franchisees and dealers. For complete warranty details and exclusions, check with your local RadioShack store.

RadioShack Customer Relations

200 Taylor Street, 6th Floor, Fort Worth, TX 76102

04/04

 RadioShack

accessories

External Antenna - Connect to your scanner's external antenna jack for great reception of signals on many frequencies.



RG-8/RG-58 50-Ohm Coaxial Cable - Use to connect your scanner to an external antenna.



12-V-to-6V, 300 mA DC adapter - Use to connect your scanner to your vehicle's battery power.

6V, 300 mA AC adapter - Use to power your scanner using an AC outlet.

PC Interface Cable (Cat. No. 20-289) - Use to connect your scanner to a personal computer so you can transfer data.